



Cycle Ingénieur – 2^{ème} année
Département Informatique

Verification and Validation

Part II : Components of the UML

Burkhart Wolff

Département Informatique

Université Paris-Sud / Orsay

Plan of the Chapter

- ❑ Introduction to the UML notation
- ❑ Syntax and semantics of class model elements and their visualization in diagrams
 - Class Invariants
 - Constraints
 - Operations
 - Pre- and Post-Conditions
- ❑ Syntax and semantics of state machines

Ultimate Goal:

Specify system components for test and verification

The UML ...

- ❑ ... is the **U**nified **M**odeling **L**anguage
- ❑ ... is a normed data-structure, a „technical format“ of **model-elements** (that may contain other model-elements) with **consistent** naming for
 - various system descriptions
 - various code formats
- ❑ ... has various external representations
 - as **XMI** exchange format (tool-independent in theory ...)
 - as UML **diagrams**

The UML offers the advantage ...

- ❑ ... of being a basis for Integrated Development Environments
(IDE's like ArgoUML, Poseidon, Rational Rose, ...)

The Shapes Project.zargo - shapes class diagram - ArgoUML

File Edit View Create Arrange Generation Critique Tools Help

Package-centric

Order By Type, Name

- Profile Configuration
- shapesmodel
 - shapes class diagram
 - Use Case Diagram 1
 - unattachedCollaboration
 - double
 - int
 - void
 - (Unnamed Generalization)
 - (Unnamed Generalization)
 - (Unnamed Generalization)
 - (Unnamed Generalization)
 - create
 - TD transient
 - TD volatile
 - (Unnamed Association)
 - OneDimensional

As Diagram

```

classDiagram
    class Shape {
        +newOperation() : void
    }
    class OneDimensional {
        +getLength() : double
    }
    class TwoDimensional {
        +getArea() : double
    }
    class Polygon {
        <<create>> +Polygon() : void
    }
    class Point {
        +x : int
        +y : int
    }
    Shape <|-- OneDimensional
    Shape <|-- TwoDimensional
    Polygon <|-- OneDimensional
    Polygon <|-- TwoDimensional
    Polygon *-- "1..*" Point : +Vertices
  
```

By Priority 9 Items

- Add Associations
- Add Instance Var
- Add Instance Var
- Add Instance Var
- Change Multiple I
- Add Operations t
- Add Constructor
- Low

Presentation Source Constraints Stereotype Tagged Values Checklist

ToDo Item

- Polygon has multiple base classes, but Java does not support multiple inheritance. You must use interfaces instead.
- This change is required before you can generate Java code.

To address this, use the "Next>" button, or manually (1)

< Back Next > Finish Help

10M used of 18M total

The UML offers the advantage ...

- ❑ ... of being a basis for **I**ntegrated **D**evelopment **E**nvironments
(IDE's like ArgoUML, Poseidon, Rational Rose, ...)
- ❑ ... to offer „**object-oriented**“ specifications
- ❑ ... to offer a **formal**, mathematical **semantics**
(well, at least to parts of the UML)
- ❑ ... to be fairly widely used in industry, even
if not always supported entirely
- ❑ ... is the basis for a whole software-engineering
paradigm called Model-Driven Engineering (**MDE**).

The UML 2.0 Diagrams (for corresp. models)

- ❑ UML, Version 1.1 : 9 types of diagrams

- ❑ UML, Version 2.0 adds

4 more types of diagrams

- structure composition
- communication
- packaging
- temporal constraints (timing)

The UML 2.0 Diagrams (for corresp. models)

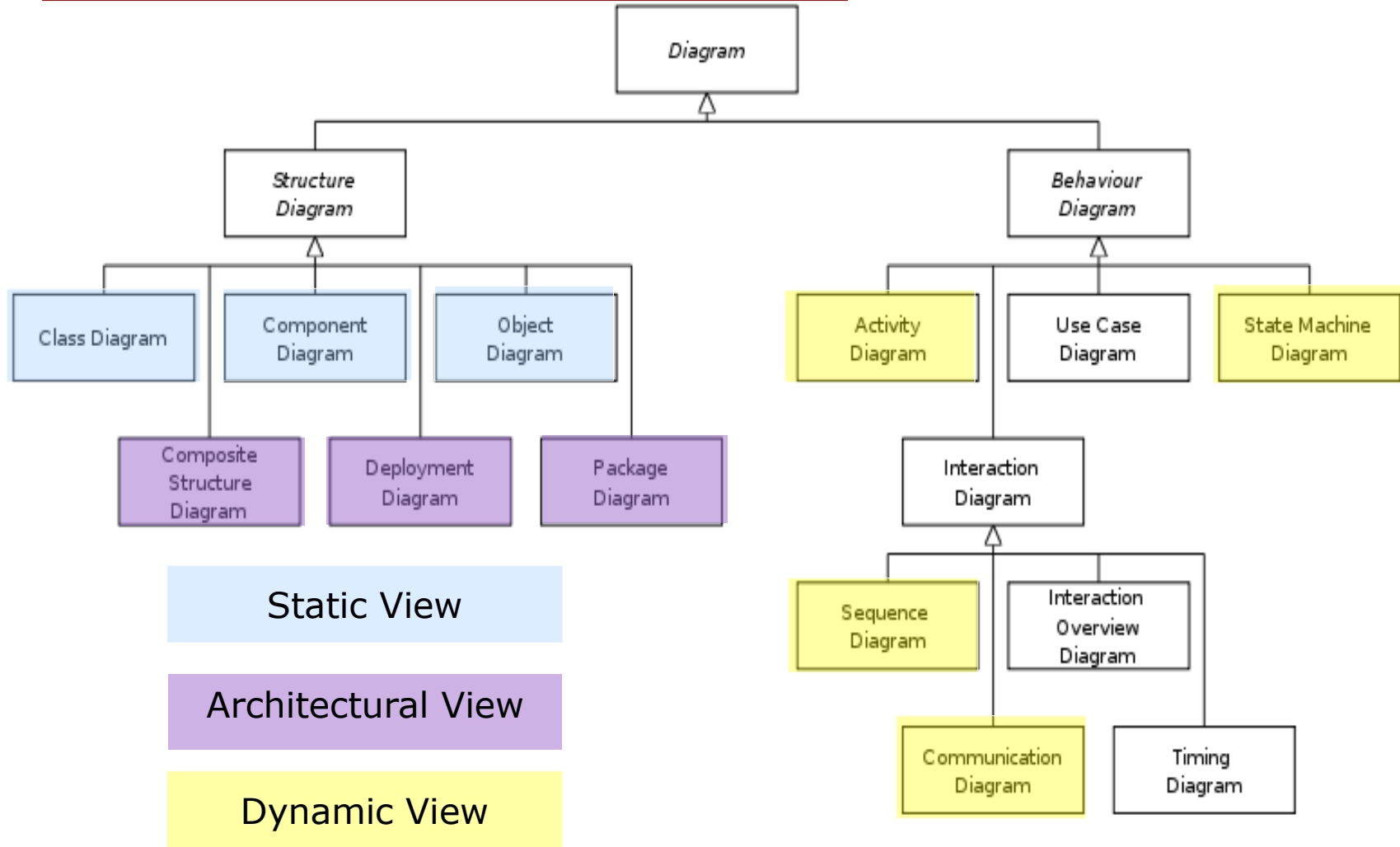

Principal UML diagram types (1)

- **Structure and Vizualization**
 - **Use Case Models and Use Case Diagrams**
 - **Sequence Models and Sequence Diagrams**
 - **State Machines and State Charts**
 - **Class Models and Class Diagrams**
 - **Object Graphs and Object Diagrams**

All these Model Elements are discribed in a UML-document itself, the „Meta-Object-Framework“ (MOF)

Principal UML diagram types (1)

- **Use Case Diagrams** („Diagrammes des cas d'utilisation") :
models the system **operations by**
 - the **interactions** of the system with the external world
(external agents communicating with the system seen as a black box.)
 - Just the principle cases, the alternatives, the extensions

Emphasis on (top-level) functionality !

Example: Use Case Diagram (Conceptual)

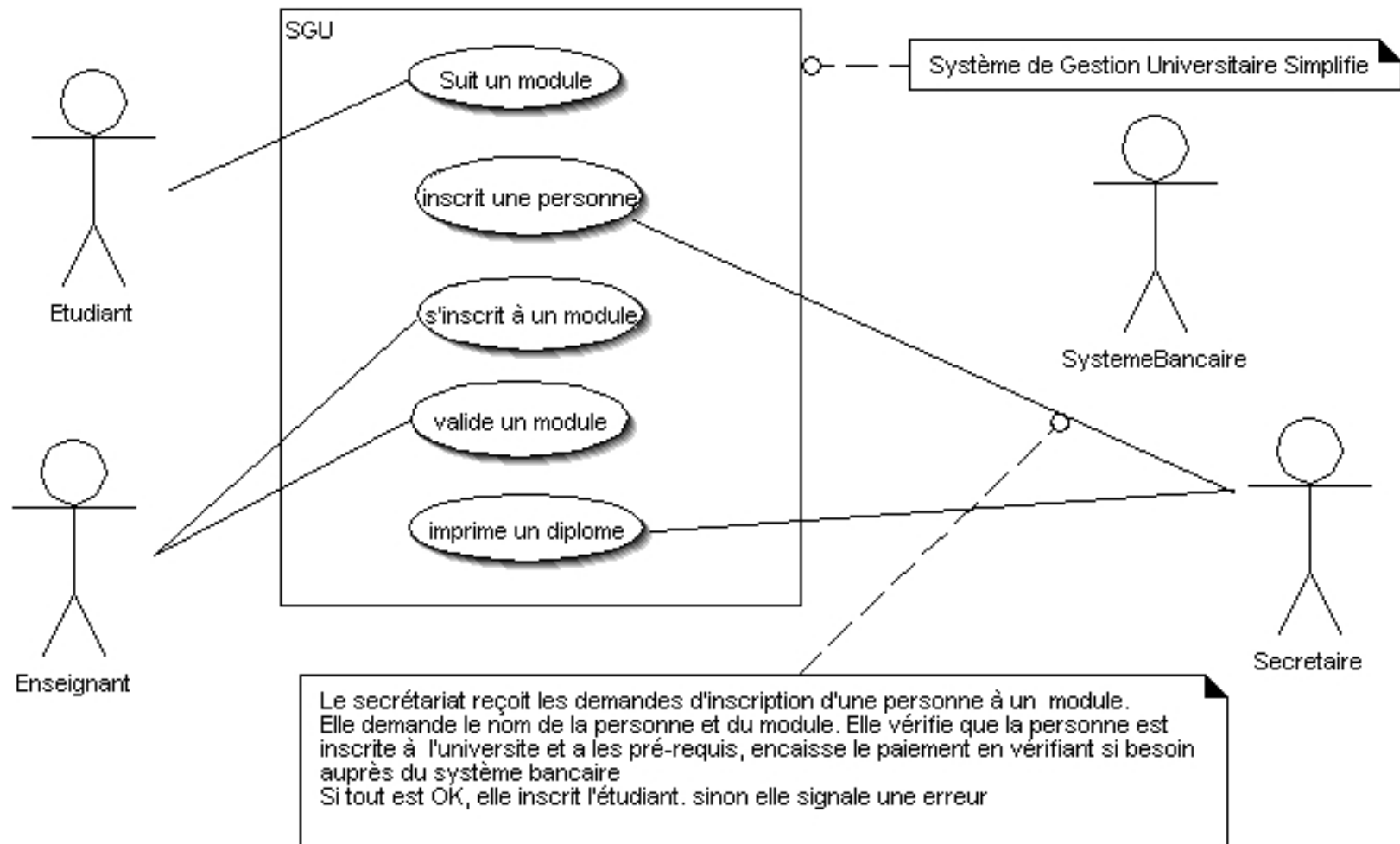

Example: Use Case Diagram (Design)

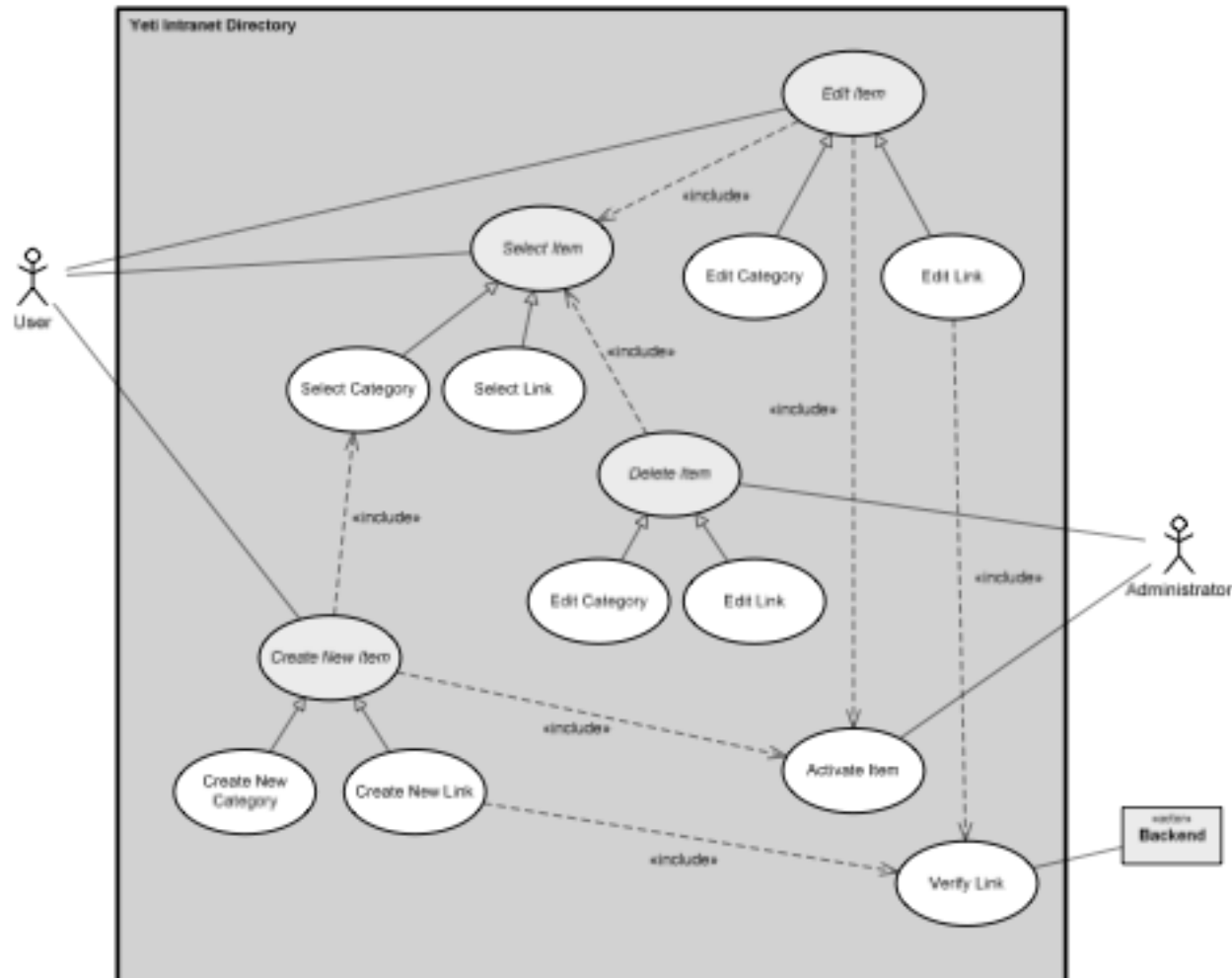

Summary: A «Use Case Diagram»

- ❑ A Use-Case Diagram
 - ... just represents the principal user-classes (**stake-holders**) of a system
 - ... and the top-level „activities“
 - ... is useful during conceptual modeling in requirement engineering
 - ... has no real semantics,

 - ... but is often used to configure templates
 - ❑ for interfaces
 - ❑ security settings

Principal UML diagram types (2)

- ❑ **Interaction Diagram** („Diagrammes d'interaction“):
the interaction between objects for realizing a functionality
 - **SequenceDiagram**: privileged temporal description of exchanges of events. Notions of utilization **scenarios**.
 - **Collaboration Diagram**: centered around objects and top-level collaborations of them.

Example: Sequence Diagram (high-level)

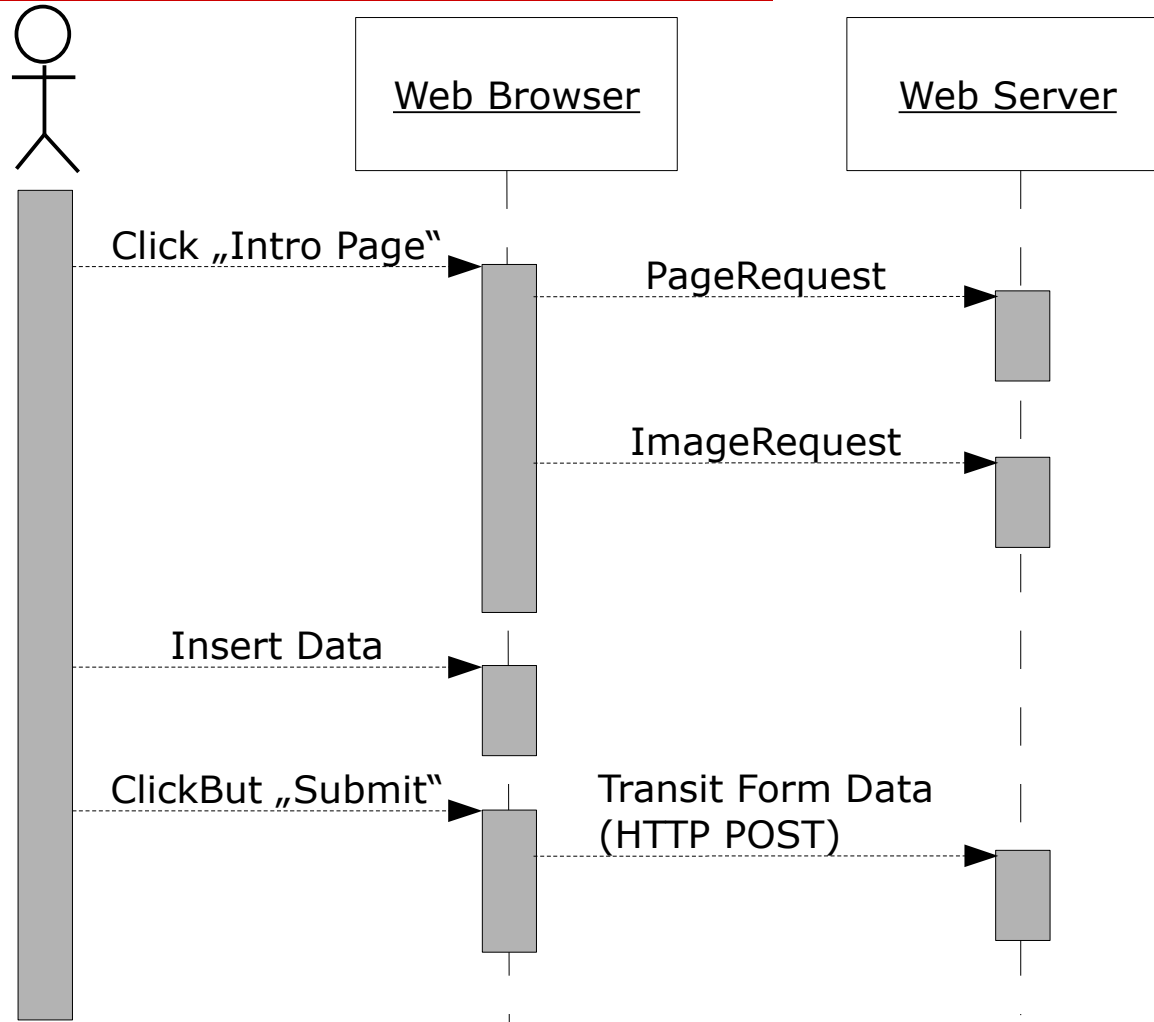

Example: Sequence Diagram (design-level)

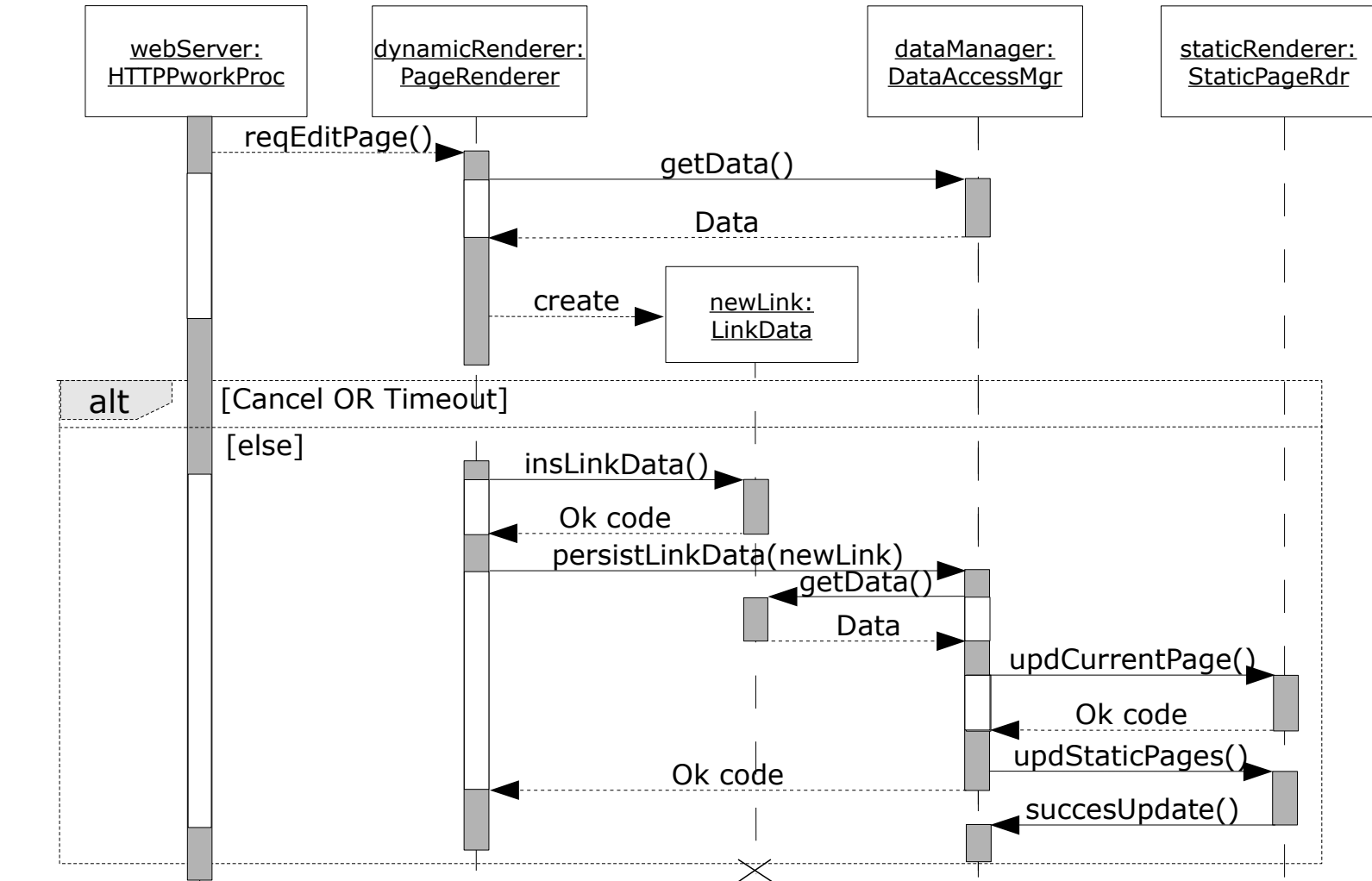

Summary: Sequence Diagrams (a)

- Two types can be distinguished:
 - **Diagrams for requirements analysis:**
description for use-case scenarios of the system, i.e. examples of the interactions of the system, i.e. of top-level behaviour. Good for error-cases.
 - **Diagrams for system or protocol design:**
communications between different instances of operations; or events occurring in state machines. Processes can be created, and synchronous and asynchronous communications were modeled. Alternatives possible.

Summary: Sequence Diagrams (b)

- Two types can be distinguished:
 - **Semantics of Diagrams for requirements analysis:** none.
 - **Semantics of Diagrams for system design:** many ;-)

Can be interpreted in Temporal Logic
and therefore in automata in many ways ...

Mostly depends what tools make out of it ;-(

Principal UML diagram types (3)

- ❑ **State Charts** (ou « machine à états ») :
a description of **behaviour** by (hierarchical) automata
 - interesting if an object reacts on events (asynchronous as well as synchronous) by the external environment
 - or if the internal state of an object leads to a somewhat interesting life-cycle of an object (transitions between well-characterized states of the object)

Example: State Chart (design level)

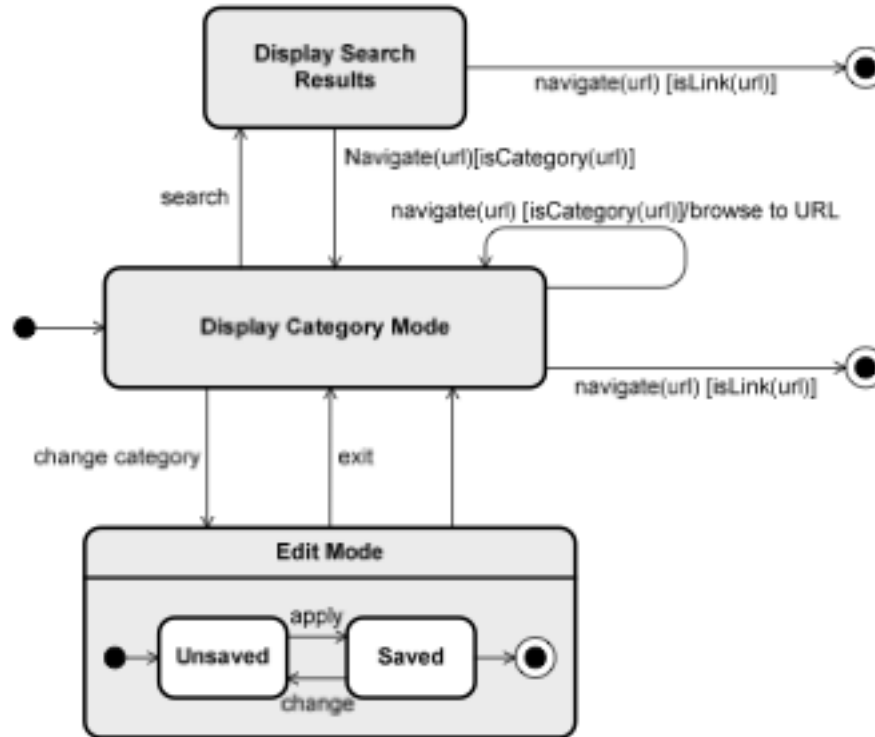

Summary: State Charts

- Two types can be distinguished:
 - **Semantics of Diagrams for requirements analysis:** many.
 - **Semantics of Diagrams for system design:** many.

Can be interpreted in by automata, process calculi, Labelled Transition Systems (LTL) in several, reasonable ways (depends on context and application).

Principal UML diagram types (4)

- ❑ **Class Diagrams** („Diagrammes de classes“) :
the static **structure** of the DATA of the system
 - the classes of interest to be represented in the system
 - the relations between classes
 - the attributes and the methods
 - the types, required/defined interfaces ...

can be used for top-level views as specific interfaces
for local code ...

Example: A Class Diagram

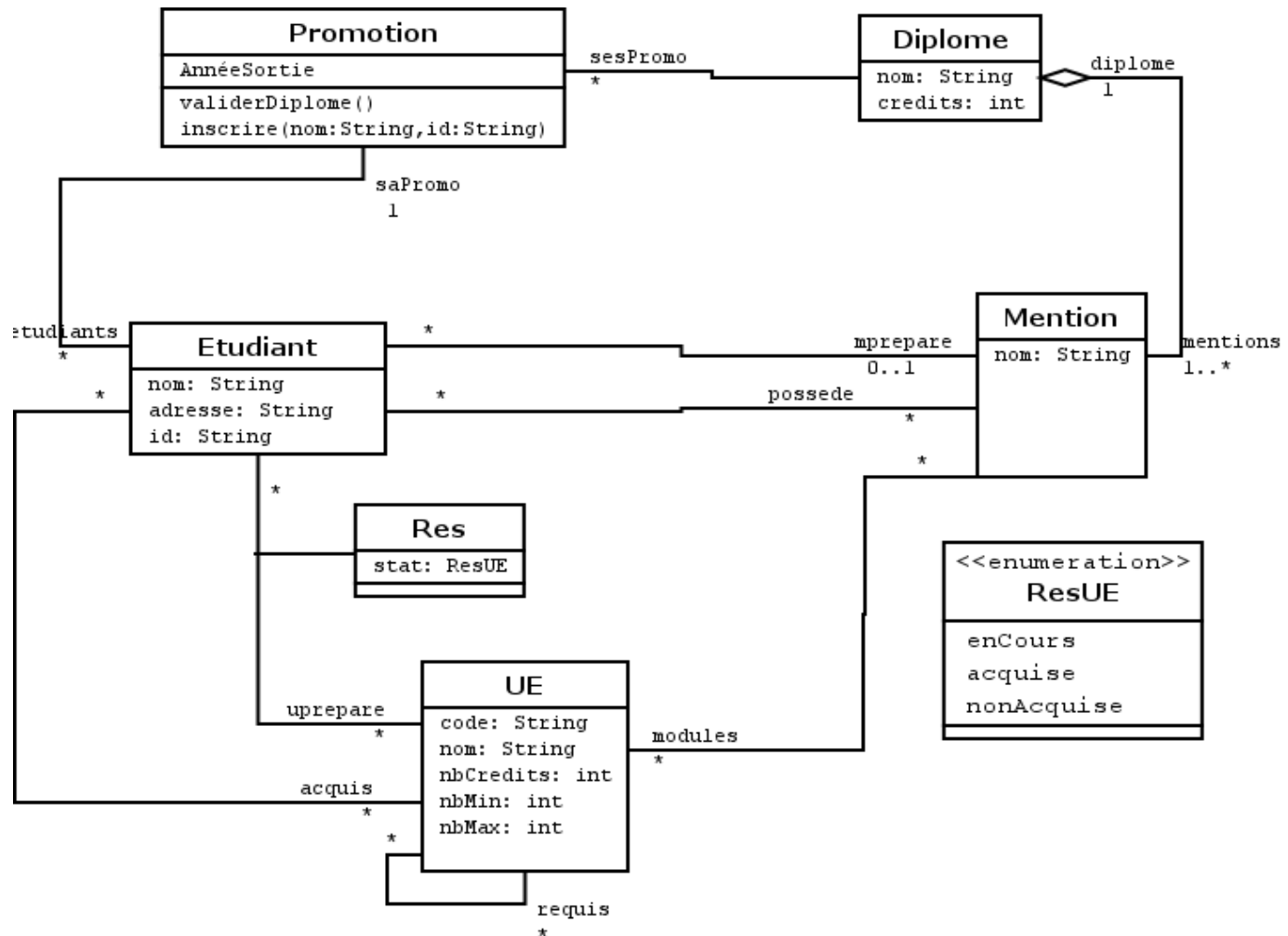

A propos Class Diagrams (1)

□ Model-Elements

➤ Class

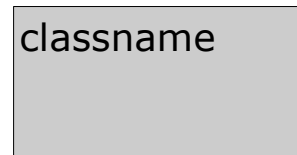

➤ Attributes

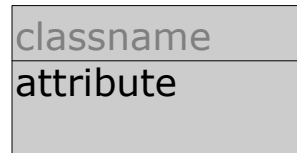

➤ Operations (methods)

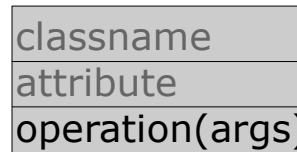

➤ Packages (grouping mechanism for parts of a class model)

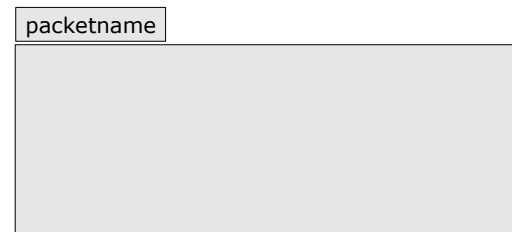

A propos Class Diagrams (2)

□ Model-Elements

- Association
(with **optional** roles
cardinalities)



- Aggregation
(« has a » relationship
with weak linkage)

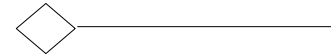

- Composition
(« has a » relationship
with strong linkage)

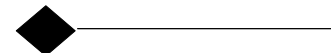

- Specialization
(modeling of a „is-a“
relationship between classes)

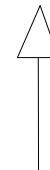

A propos Class Diagrams (3)

□ Model-Elements

- Visibilities
(**optional** public
and private, see more later)
- N-ary associations
- Association Class
- templates with parameter
(usually classes)

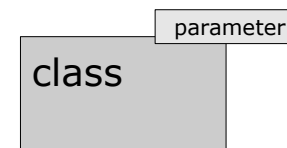
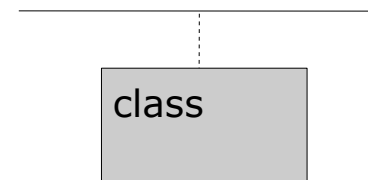
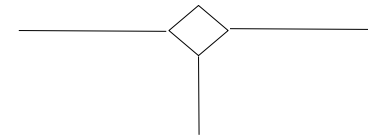
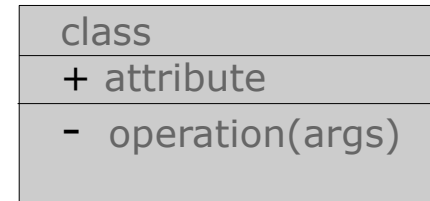

A propos Class Diagrams (4)

□ Model-Elements

> Annotations

... typically on classes

... can be informal text as well as OCL (see next part !)

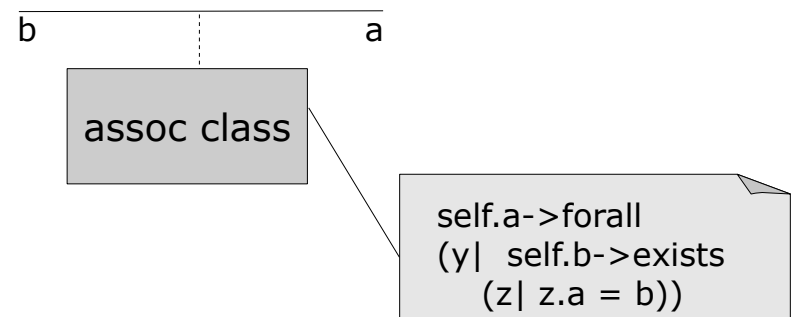
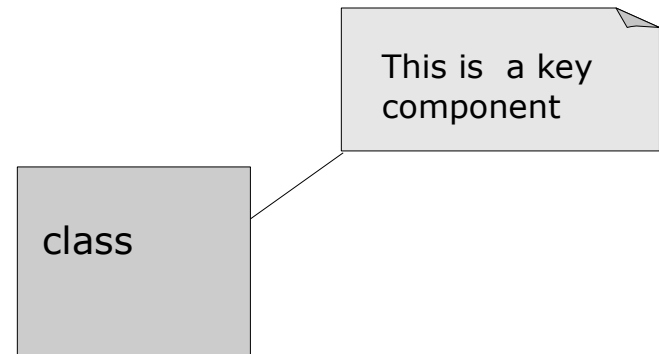

A propos Class Diagrams (1)

- ❑ Semantics: Classes are:
 - types of objects
 - tuples „attributes“ AND association ends (« roles »), which are collections (Set, Sequence, Bag) of references to other objects
 - objects may be linked via references to each other into a state called „object graph“
 - cardinalities, etc. are INVARIANTS in this state.

A propos Class Diagrams (2)

- Attributes
 - can have simple type (Integer, Boolean, String, Real) or primitive type (see Date example) only !
 - in diagrams, attributes may NOT have collection type (use therefore **associations**)
 - In a requirement analysis model, everything is **public** by default (we will refine this notion later)

A propos Class Diagrams (3)

- ❑ operations (in an analysis class diagram)
 - we will only distinguish operations linked to a use-case diagram
 - we will sometimes not even link them to a specific class - this will come later.

- ❑ operations (in an design class diagram)
 - a complete interface;
can be compiled from a JAVA Interface !

Class Diagrams in Requirements Analysis

The **static aspects** of a model were represented by

➤ **The class diagram**

Classes with their attributes

Class hierarchies via inheritance

Relations between classes (associations + cardinalities)

The „roles“ at the association ends give an intuitive semantics

➤ **The invariants** make the description complete ...
ce qui n'est pas exprimable directement dans le diagramme

Plages de valeurs ou contraintes sur des attributs

Contraintes complexes sur une association isolée

Contraintes globales sur un ensemble d'attributs/associations

~~Contraintes sur un ensemble d'instances des classes~~

More Specific Details in UML 2

Visibilities:
 +: public
 - : private
 #: protected
 / : derived

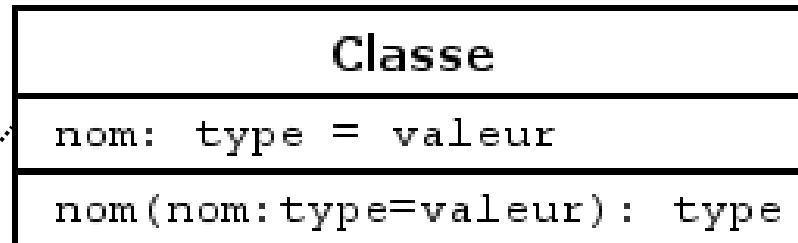

Modifiers:
static
abstract

Parameter modes:
 in (par défaut)
 out
 in out

Instances:



Stéréotypes:

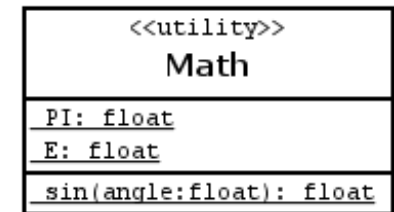
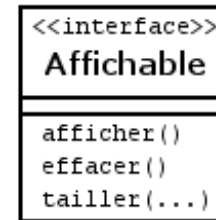
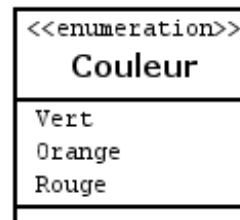
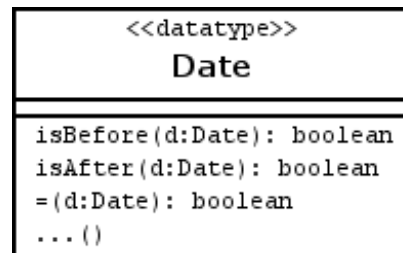

More Specific Details in UML 2

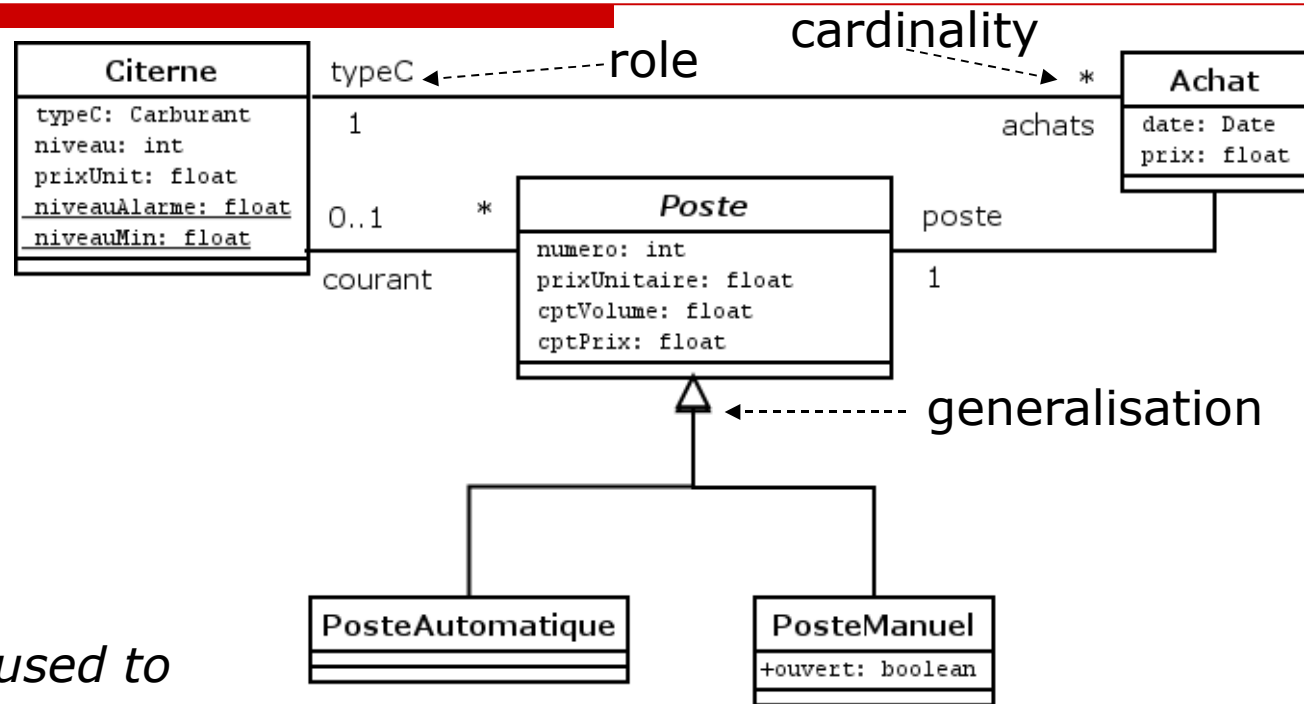

The roles were used to navigate accross associations

- for `a:Achat`, the OCL expr `a.poste` denotes an instance of `Poste`.
- for `c:Citerne`, the OCL expr `c.achats` denotes an instance of `Achat`
- for `p:Poste`, the OCL expr `p.courant` corresponds to a collection of 0 or 1 instances of `Citerne`.

Le nom de classe peut servir de rôle par défaut (si pas d'ambiguïté)

More Specific Details in UML 2

Cardinalities in associations can be:

- 1, 2, or an integral number (no expression !)
- * (for « arbitrary », ...)
- an interval like 1..*, 0..1, 1..3, (**not** like 1..N)
 - on donnera systématiquement les cardinalités
 - Attention à la distinction: une instance (1), au plus une instance (0..1), une collection d'instances (* ou 1..*)

Multiplicities on attributes and classes can be:

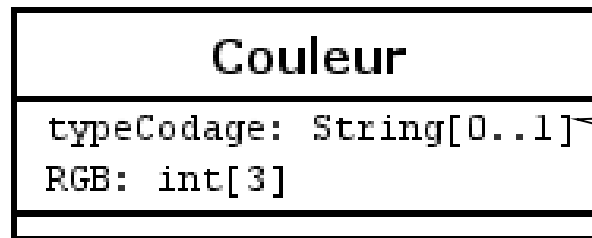

*0 or 1 String,
not string of
length 0 or 1 !!!*

More Specific Details in UML 2

Constraints on associations

- For generalisation:
 - complete, incomplete
 - disjoint, overlapping
- Between associations
 - xor
- Collection Types may now also be specified !!!
 - no duplicates, unordered
 - duplicates, unordered
 - no duplicates, ordered
 - duplicates, positioned

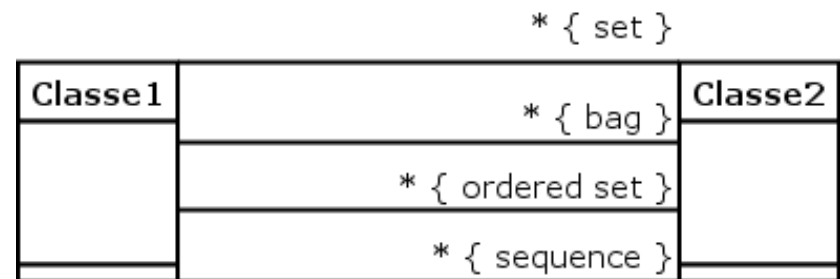
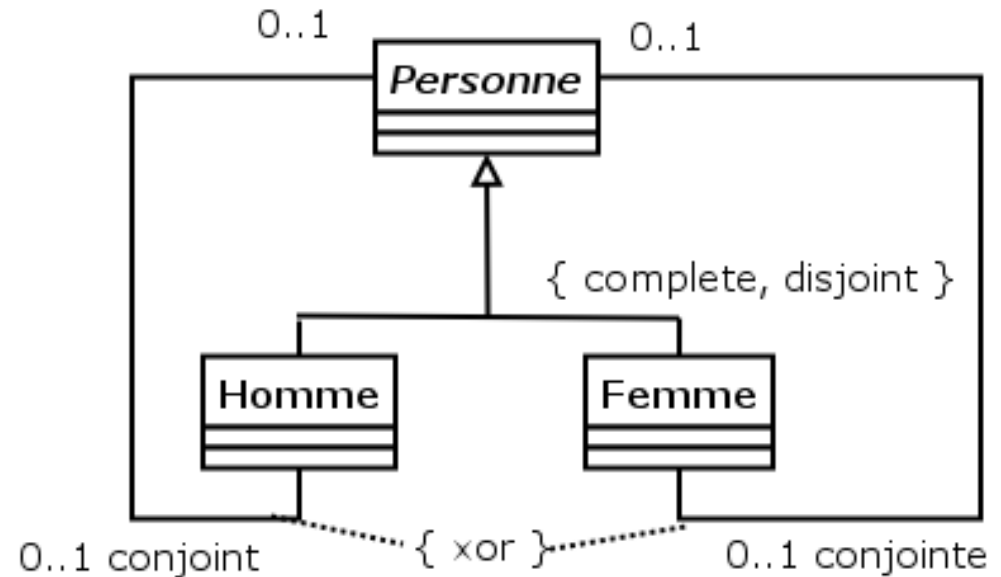

More Specific Details in UML 2

N-ary Associations

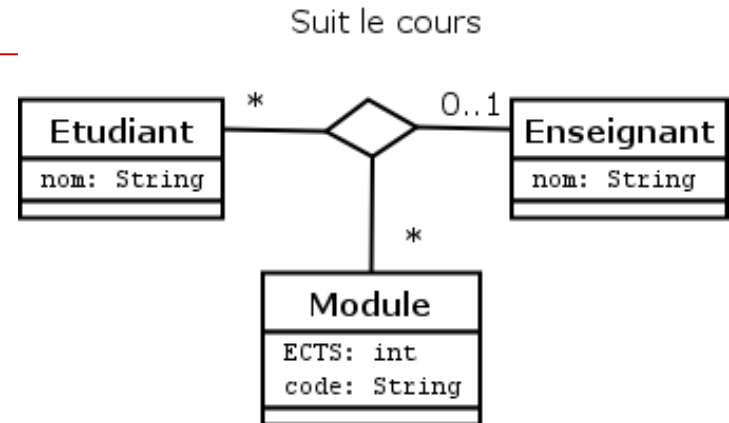

Association with attributes

Association « qualified »

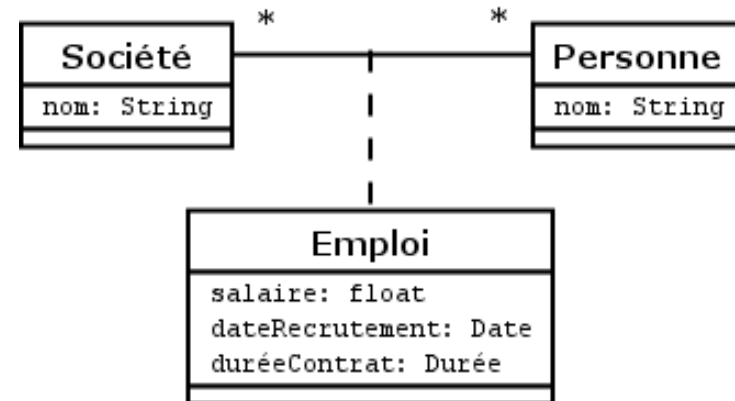
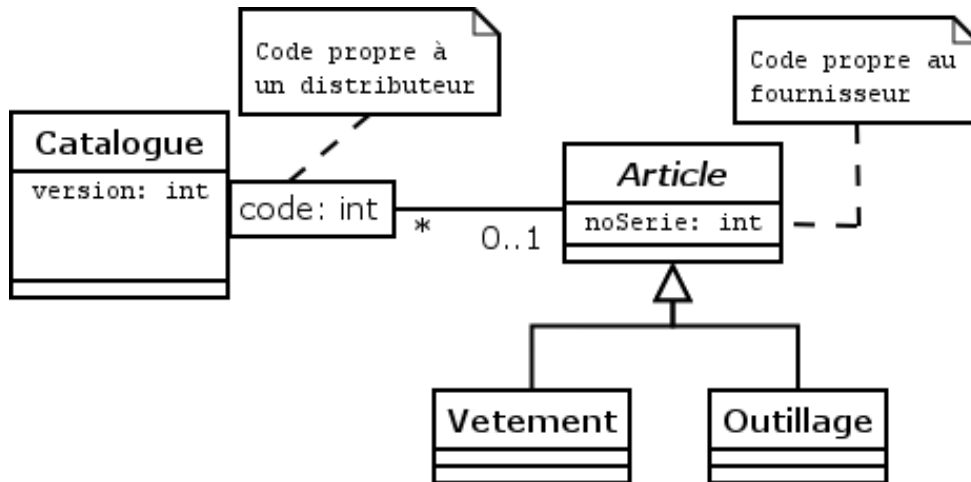

Putting all together ...

Inspiré de: « UML 2.0 Guide de référence »,
Rumbaugh et alli., CampusPress, 2005

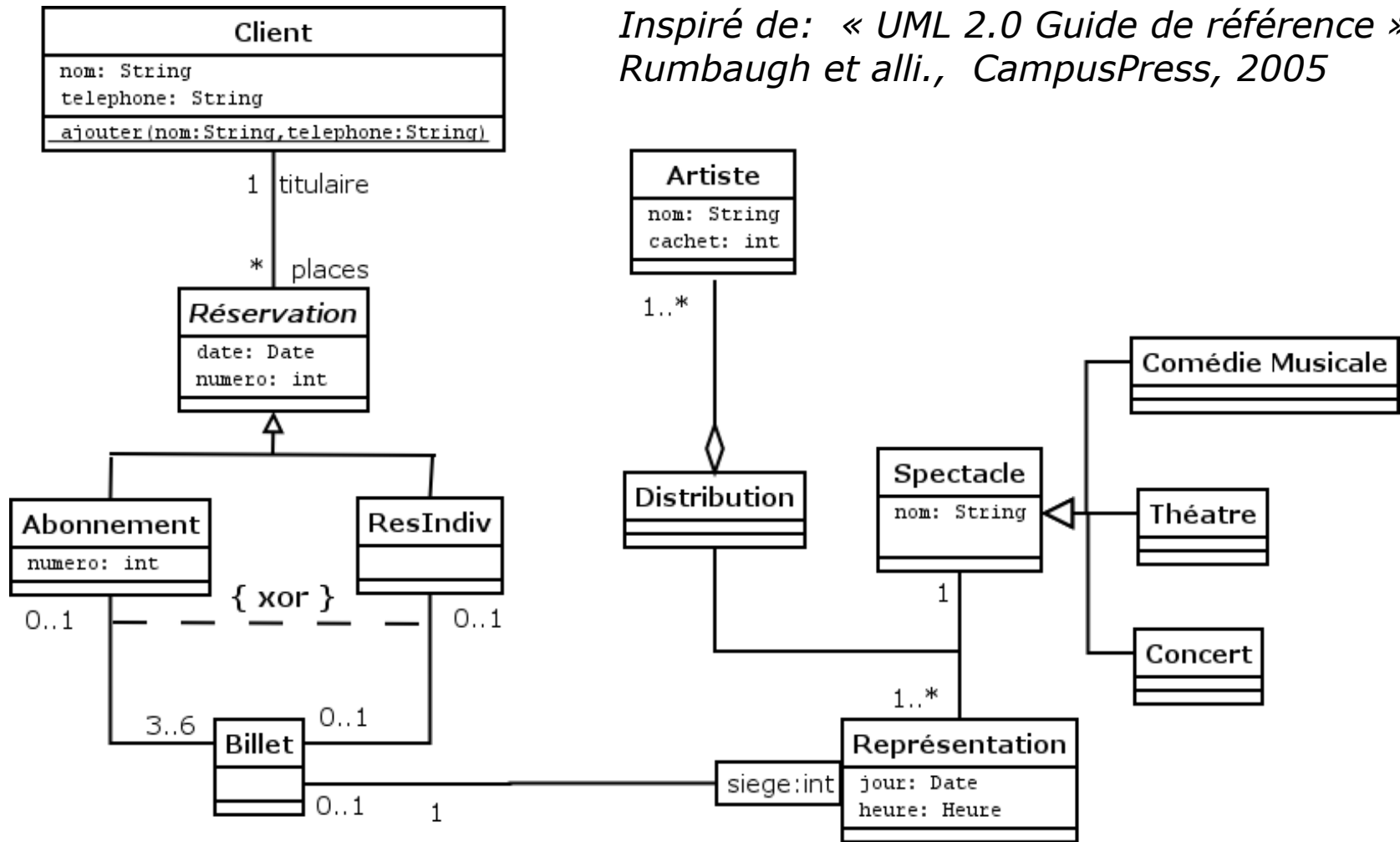

Principal UML diagram types (5)

❑ **Object Diagrams** („Diagrammes d'objects") :

denote a concrete system state,

❑ typically used in connection with a Class Diagram

- attributes have concrete values
- associations were replaced by directed arcs representing the links

can be used for debugging purposes ...
(semantics: fully clear).

Example Object Diagram

- Corresp. Object Diagram

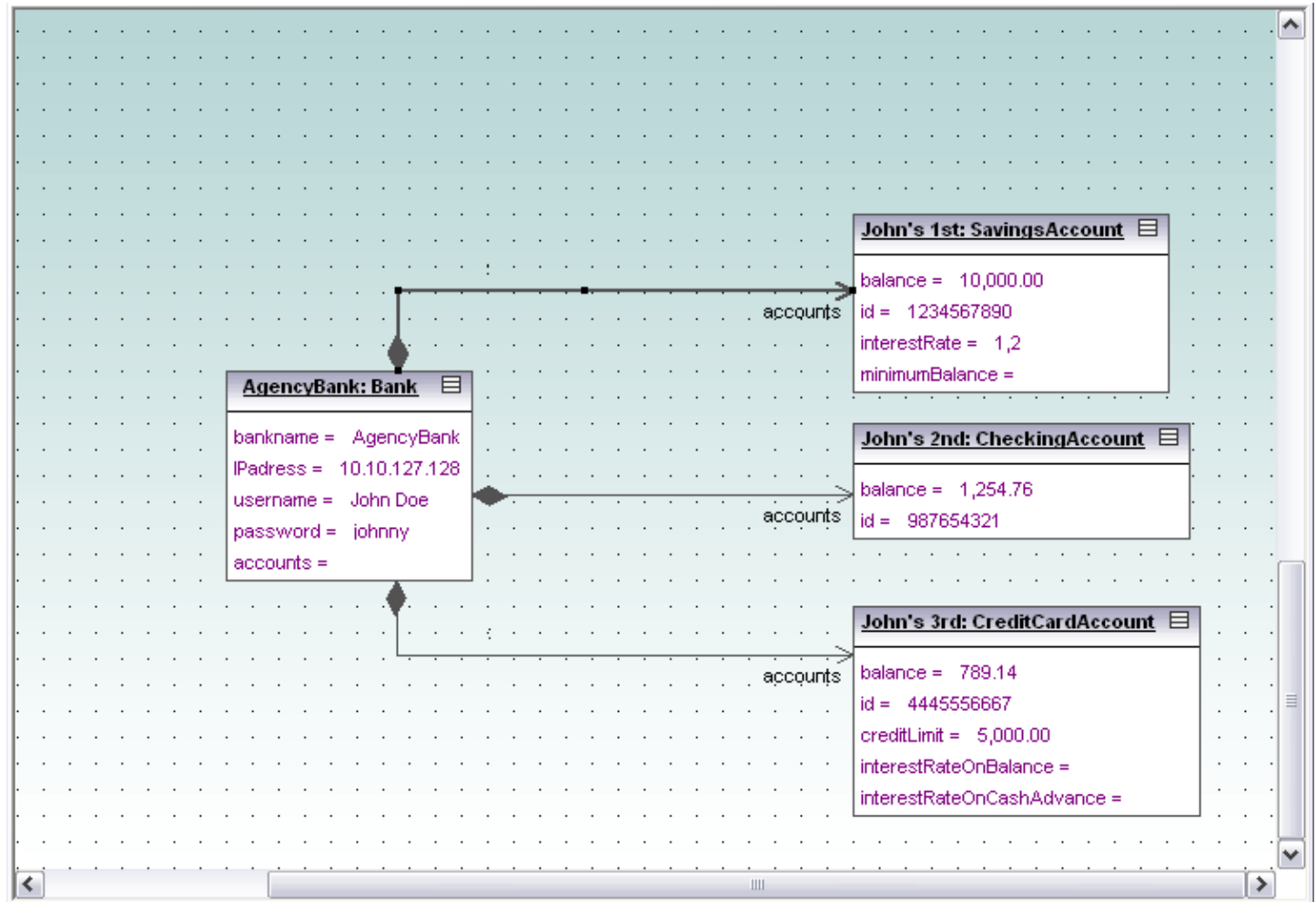

Example Object Diagram

Class Diagram

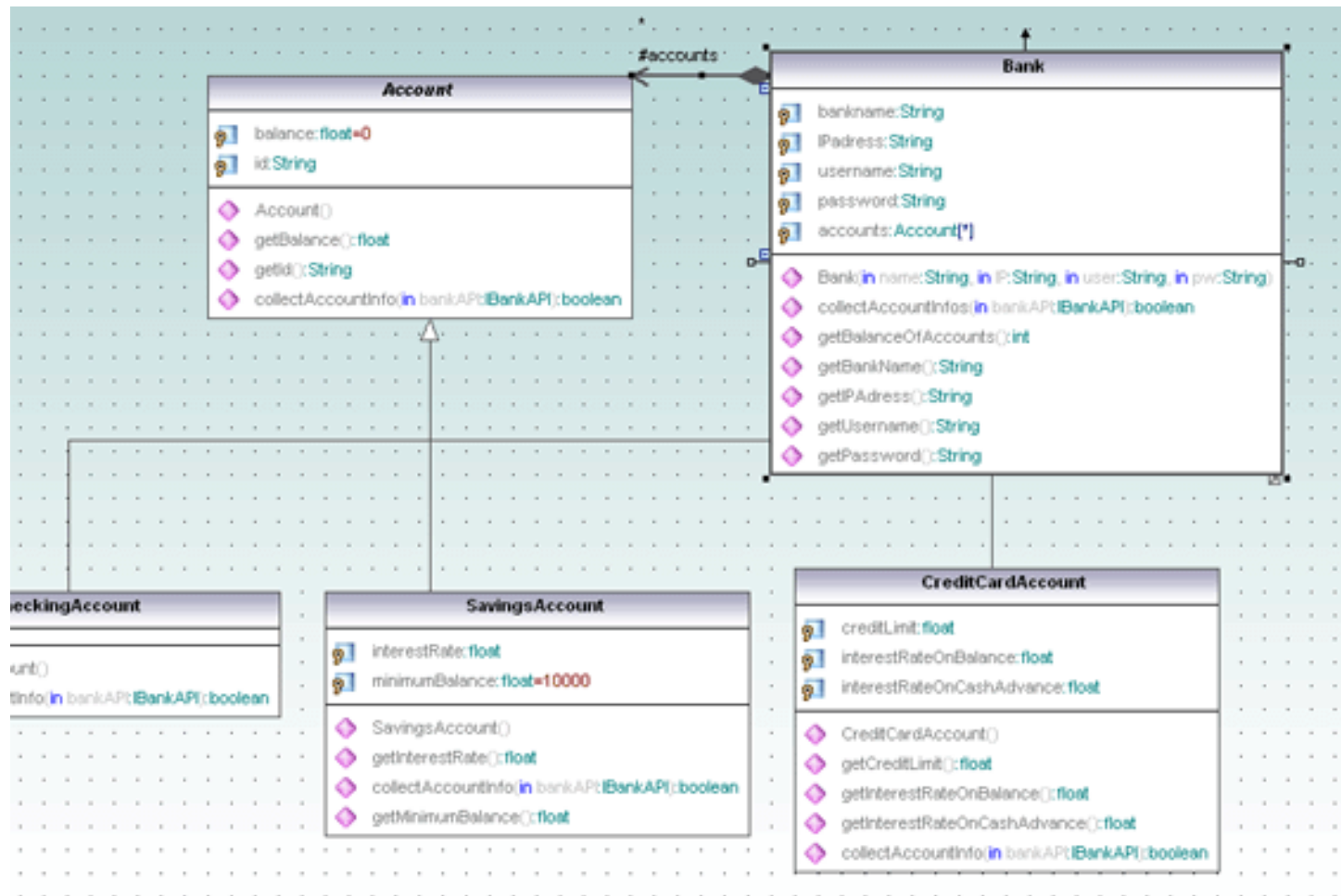

Summary: Object Diagrams

- ❑ Object Models denote a concrete State of a Class Model; Class Diagram denote (essentially) a Signature of the elements in the state, as well as the possible operations on them.

Multiplicities and Cardinalities express INVARIANTS on (valid) Object Models to a given Class Model - with this respect, serves as Specification of States.

A propos Class Diagrams (3)

- ❑ Not all constraints on an object graph can be expressed by arrows so far:
 - The student numbers should be distinct
 - A student can not acquire a module he has already finished
 - A module may not be part of the pre-requisites "pré-requis"
 - A student may only follow a module if he has acquired the necessary pre-requisites
 - A student can only follow modules offered at his „filière"
 - ...

Example of a State Machine: a (teaching) module

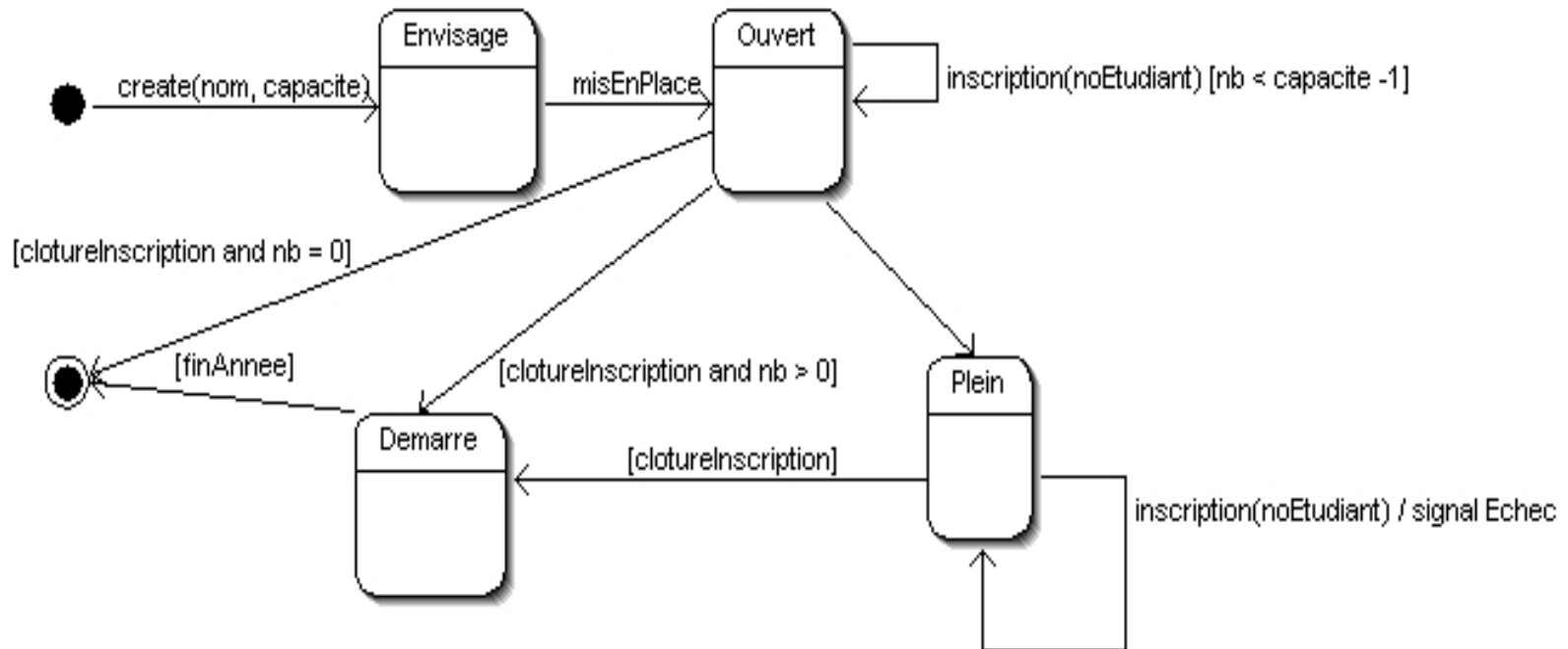

« L'ouverture des modules est décidée en début de semestre et dépend de l'inscription effective d'étudiants. La capacité d'accueil est fixe et les inscriptions prises dans l'ordre d'arrivée. Aucune inscription n'est admise une fois le module démarré. »

This describes the life-cycle of an isolated module ... will we find this later on in the implementation the equivalent of the possible transitions ?

A propos Class Diagrams (3)

- Not all constraints on an object graph can be expressed by arrows so far:
 - ...
 - a student can only subscribe a module if he is targeting for a diplome
 - Il existe un facteur 3 au plus entre les nombres de crédits de deux U.E. d'une même mention (cas des Licences) ???
- ☞ we will need mechanisms to describe all this in the design phase !!! (Object Constraint Language, OCL)